

Mobile Crane Grue automotrice

LTM 1220-5.2

Technical Data Caractéristiques techniques

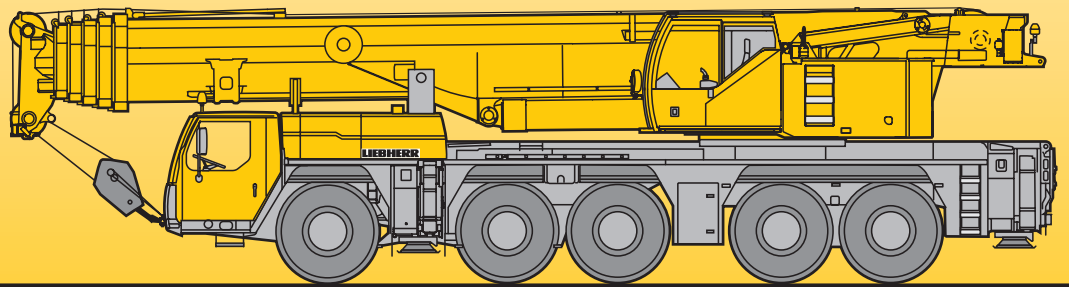

LIEBHERR

Lifting heights Hauteurs de levage

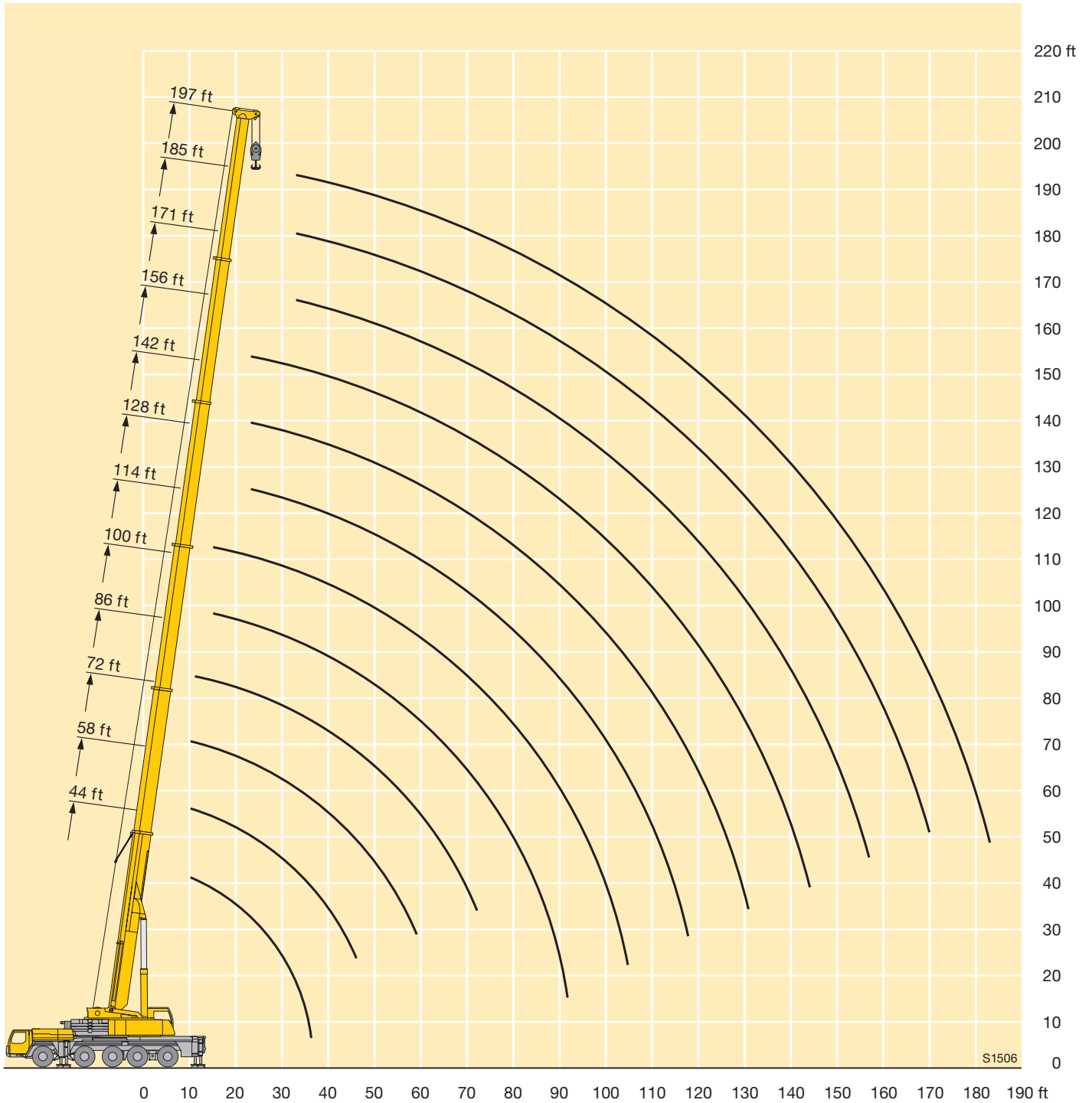

Lifting heights Hauteurs de levage

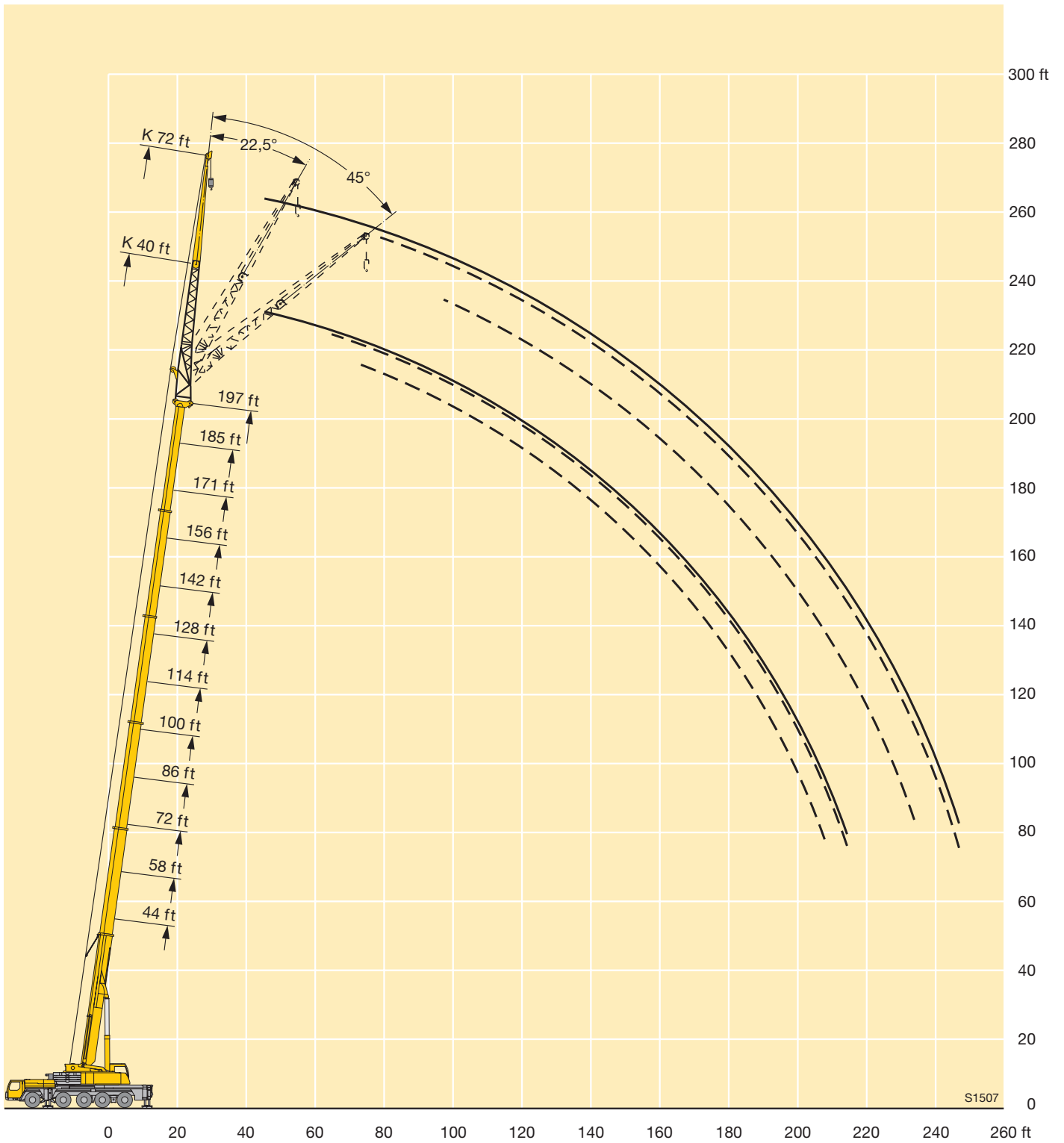

Lifting heights Hauteurs de levage

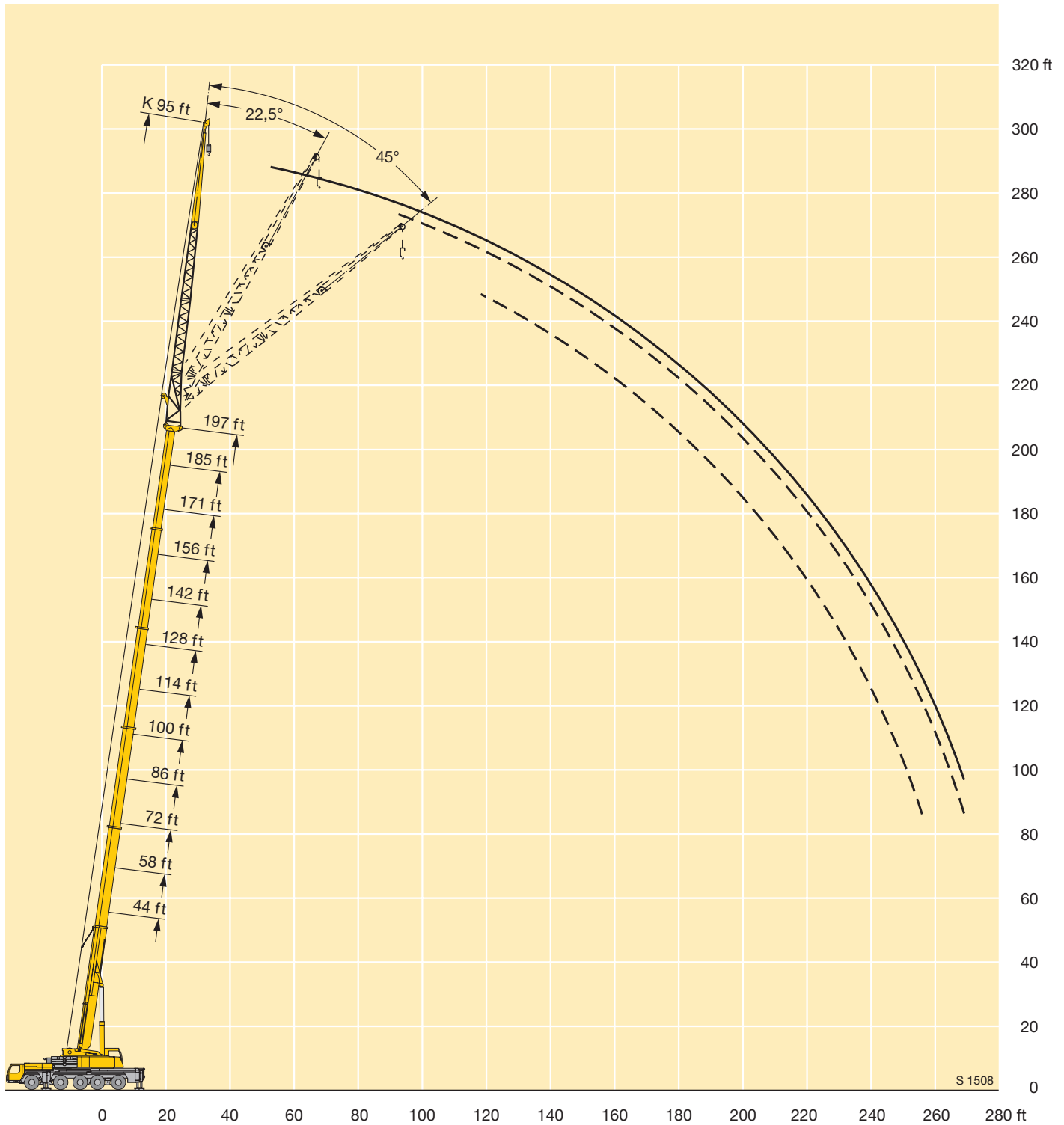

Lifting heights Hauteurs de levage

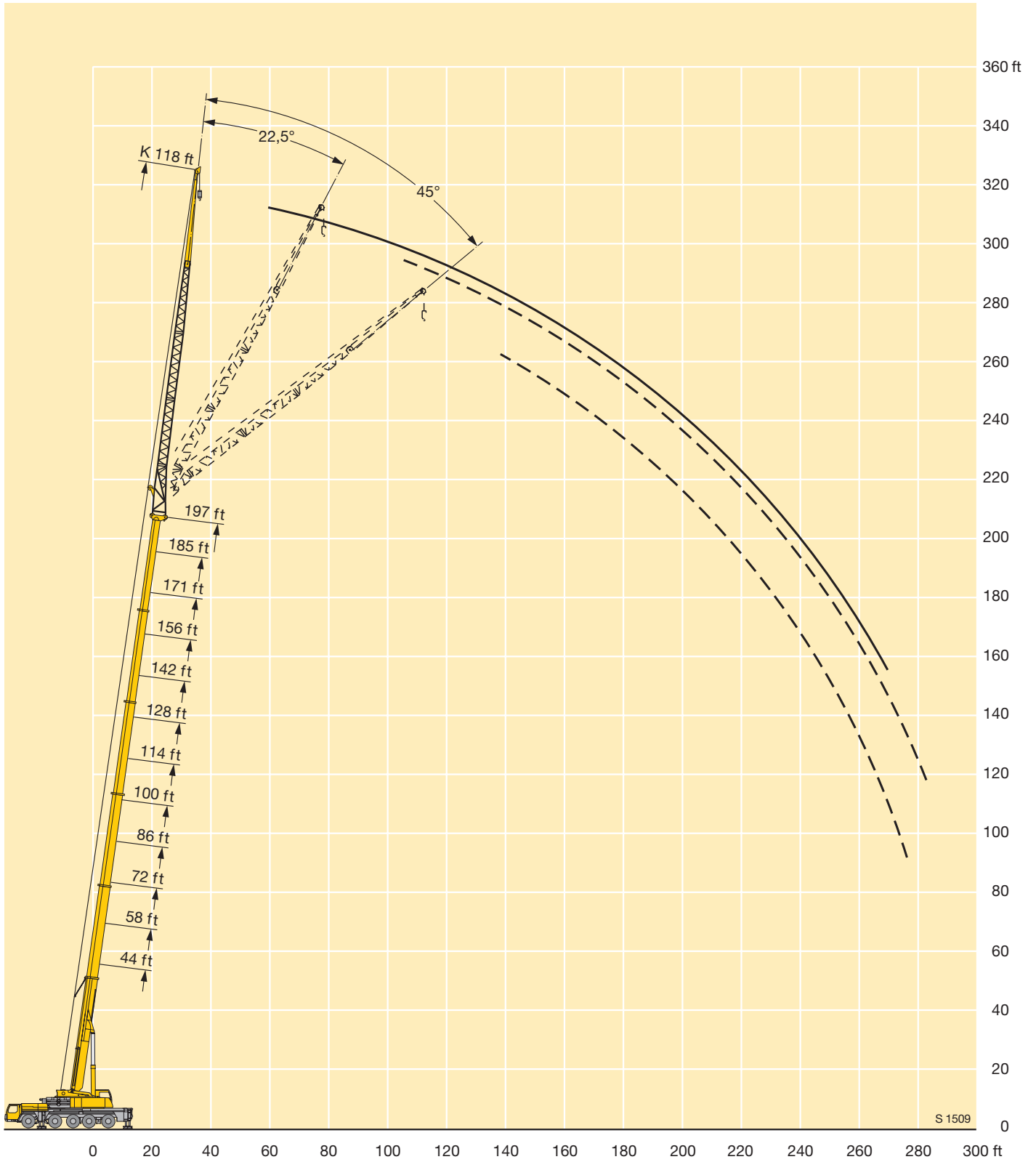

Lifting heights Hauteurs de levage

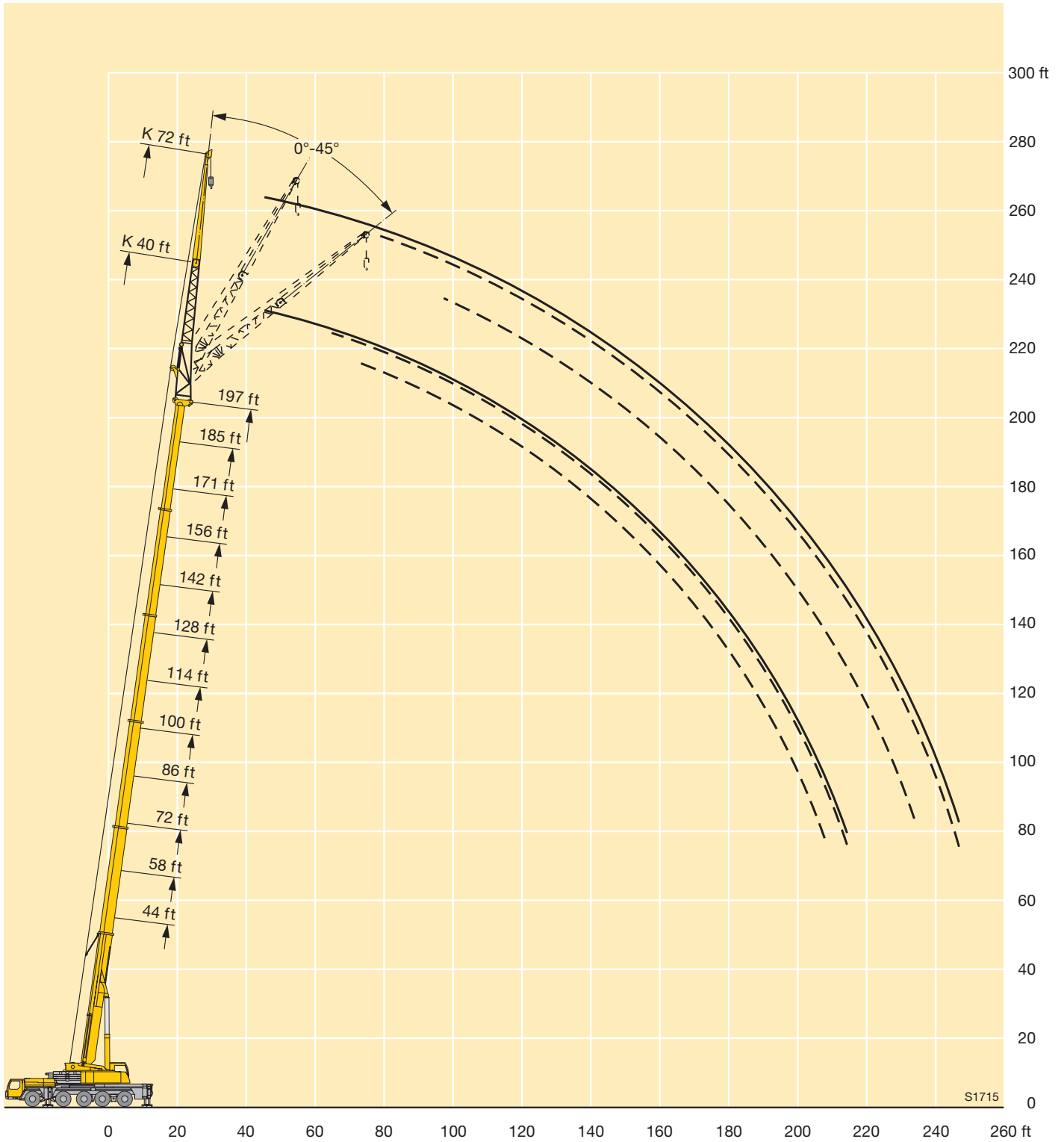

Lifting heights Hauteurs de levage

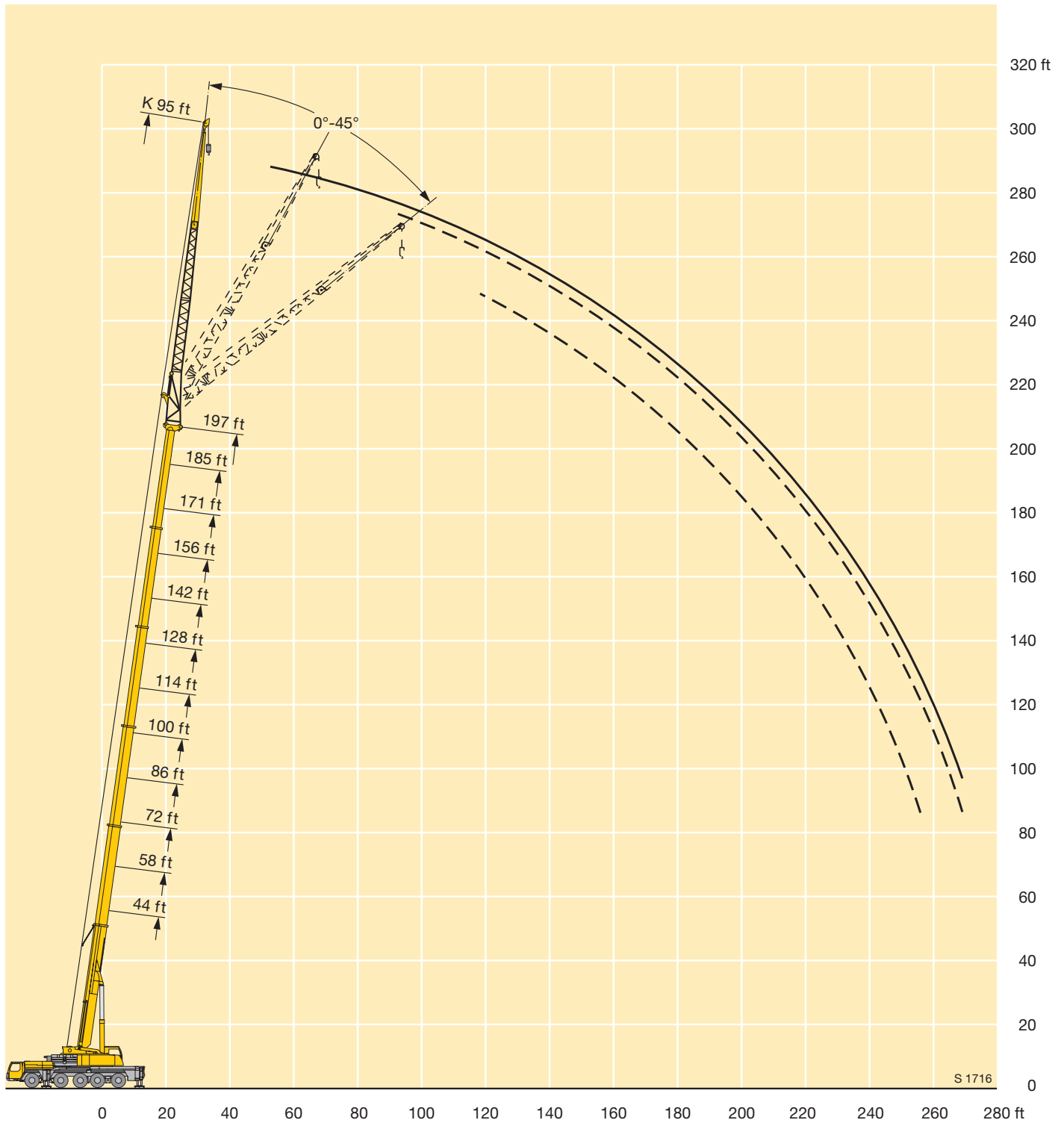

Lifting heights Hauteurs de levage

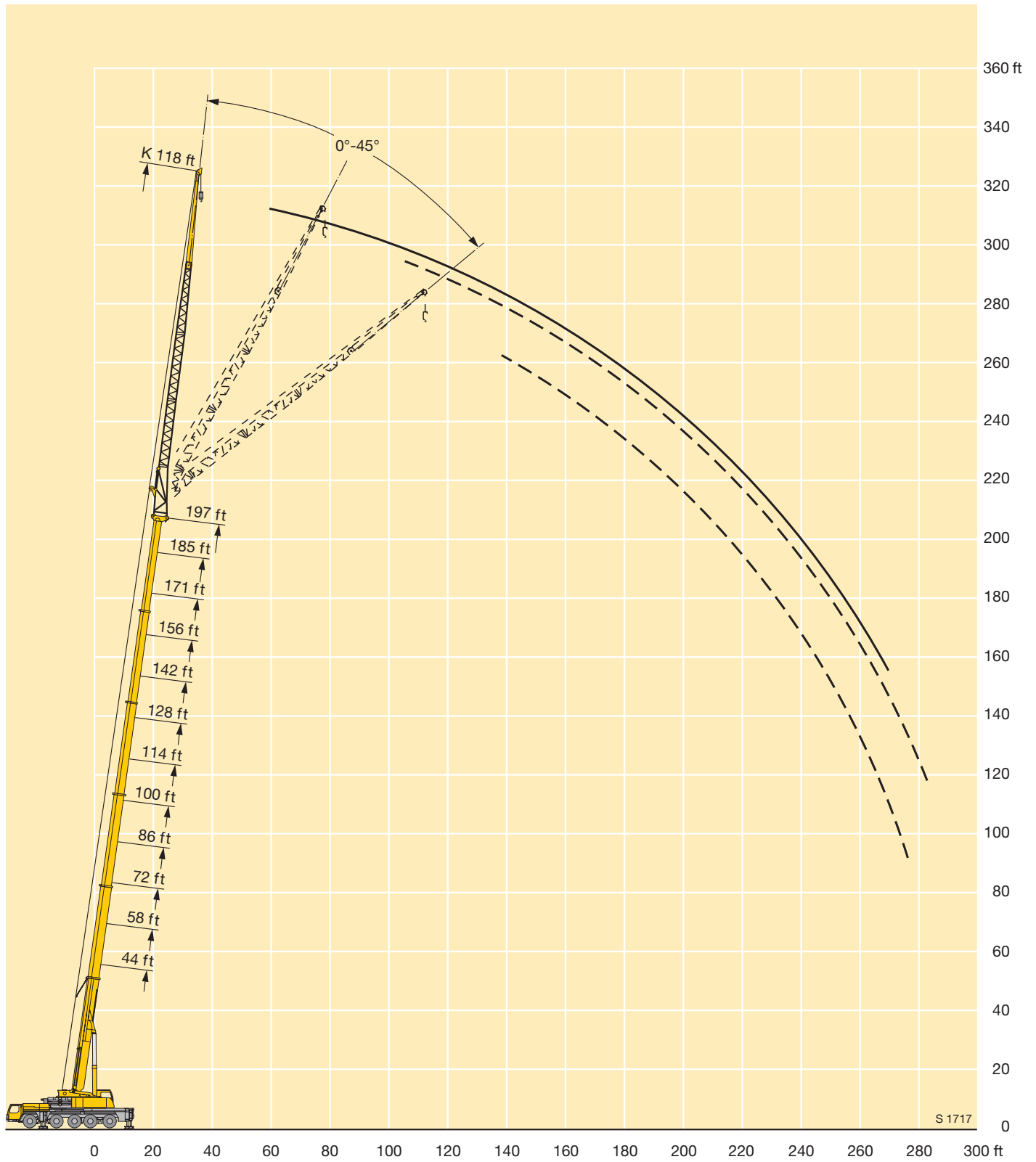

Lifting heights Hauteurs de levage

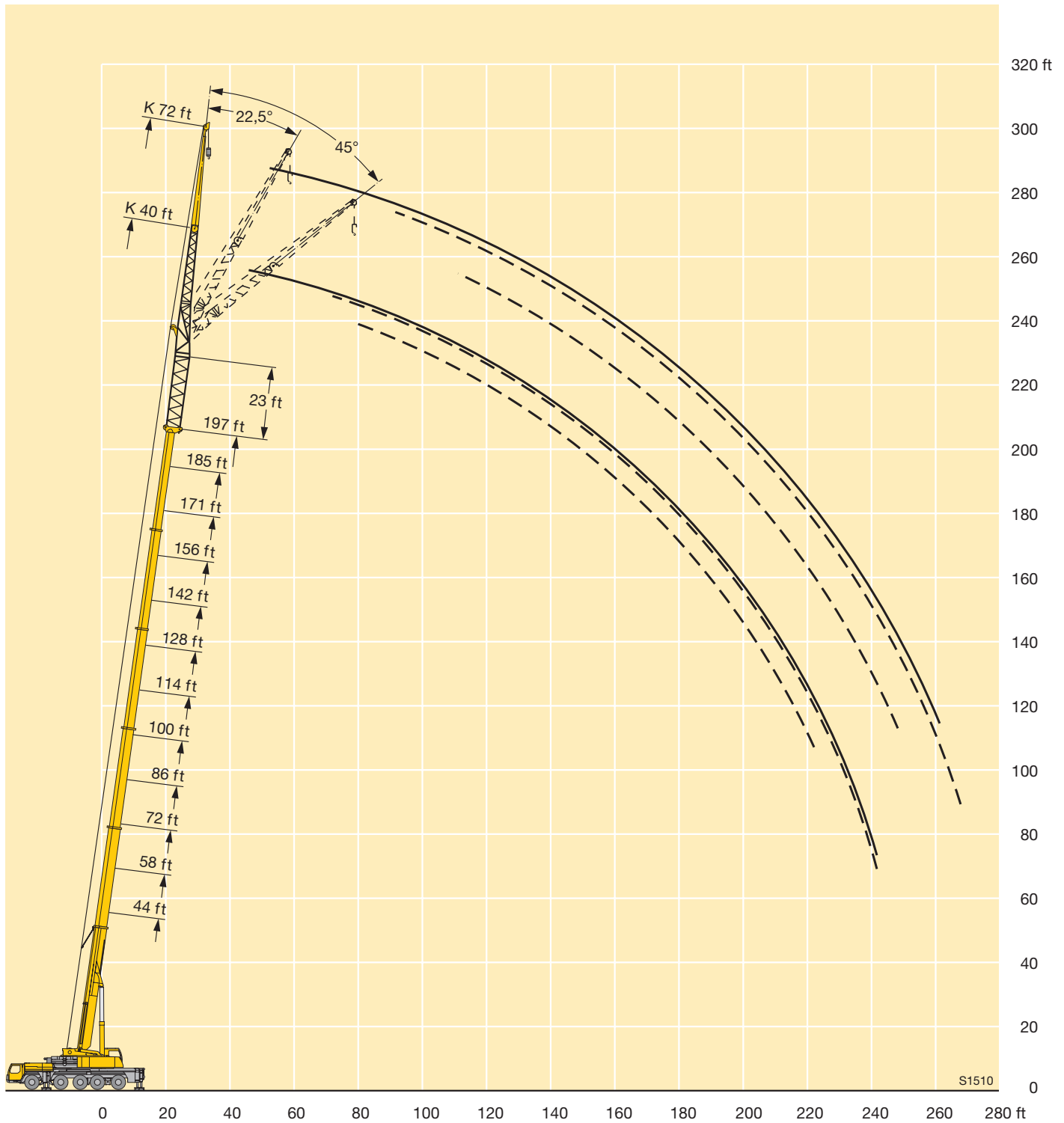

Lifting heights Hauteurs de levage

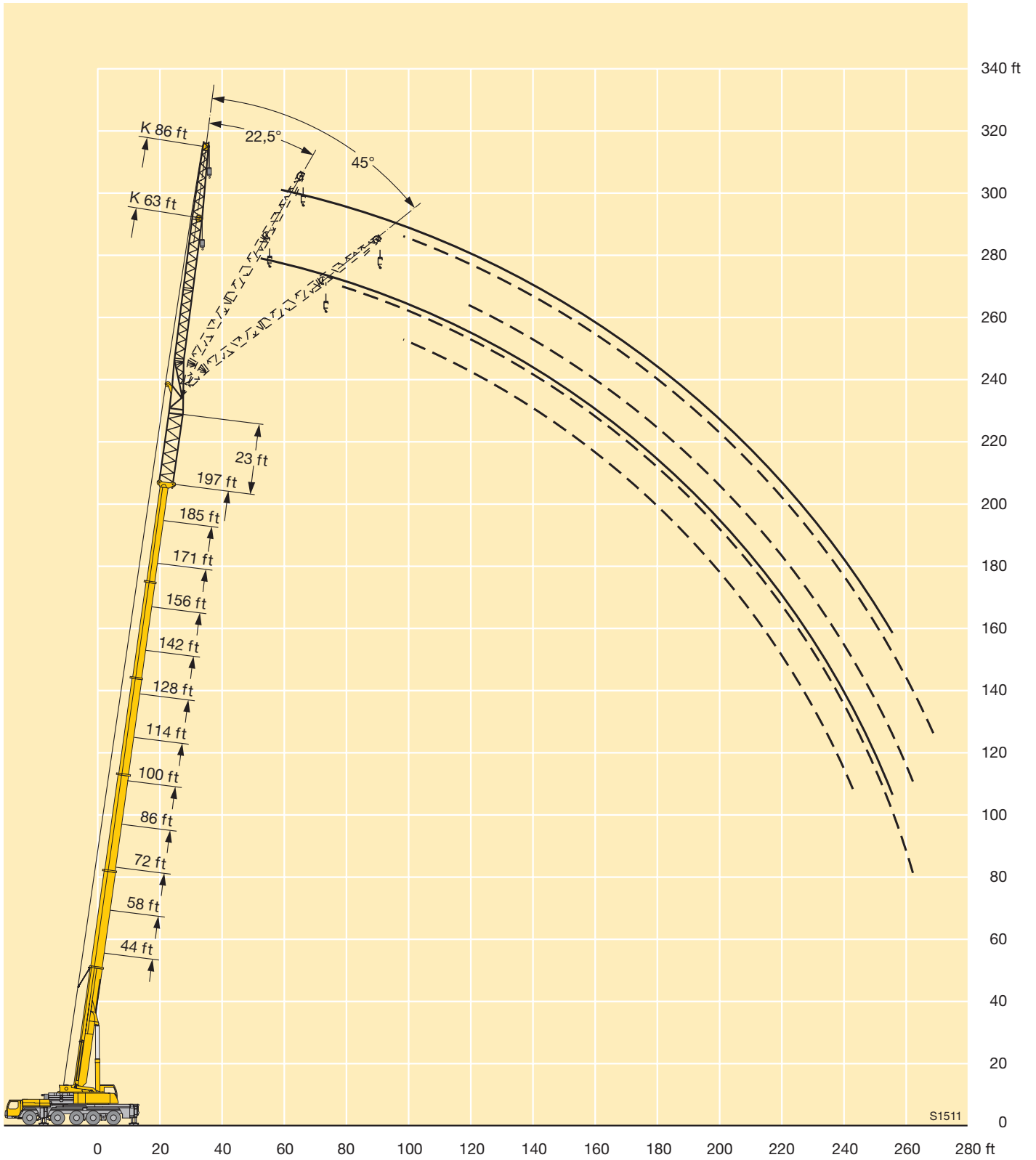

Lifting heights Hauteurs de levage

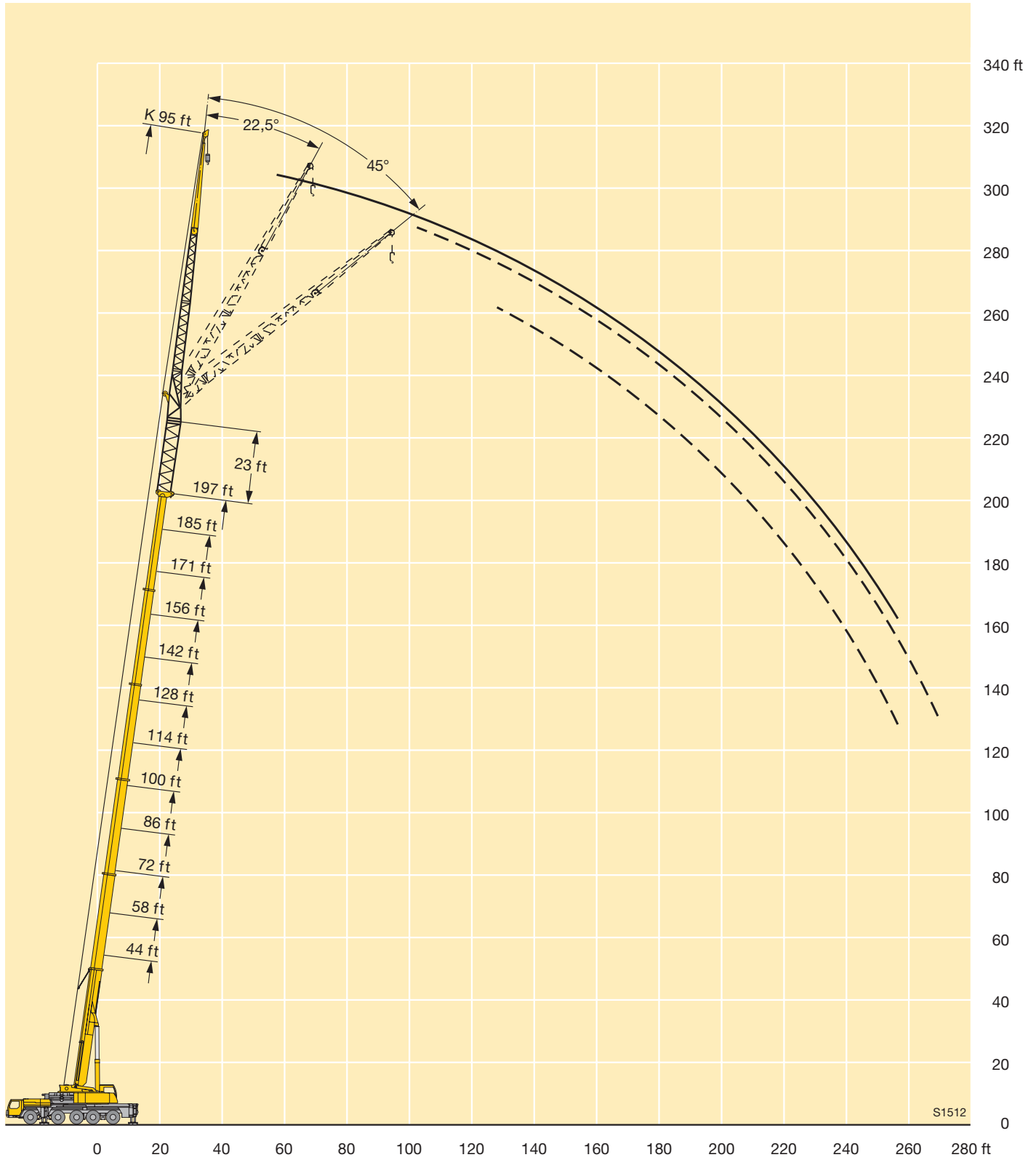

Lifting heights Hauteurs de levage

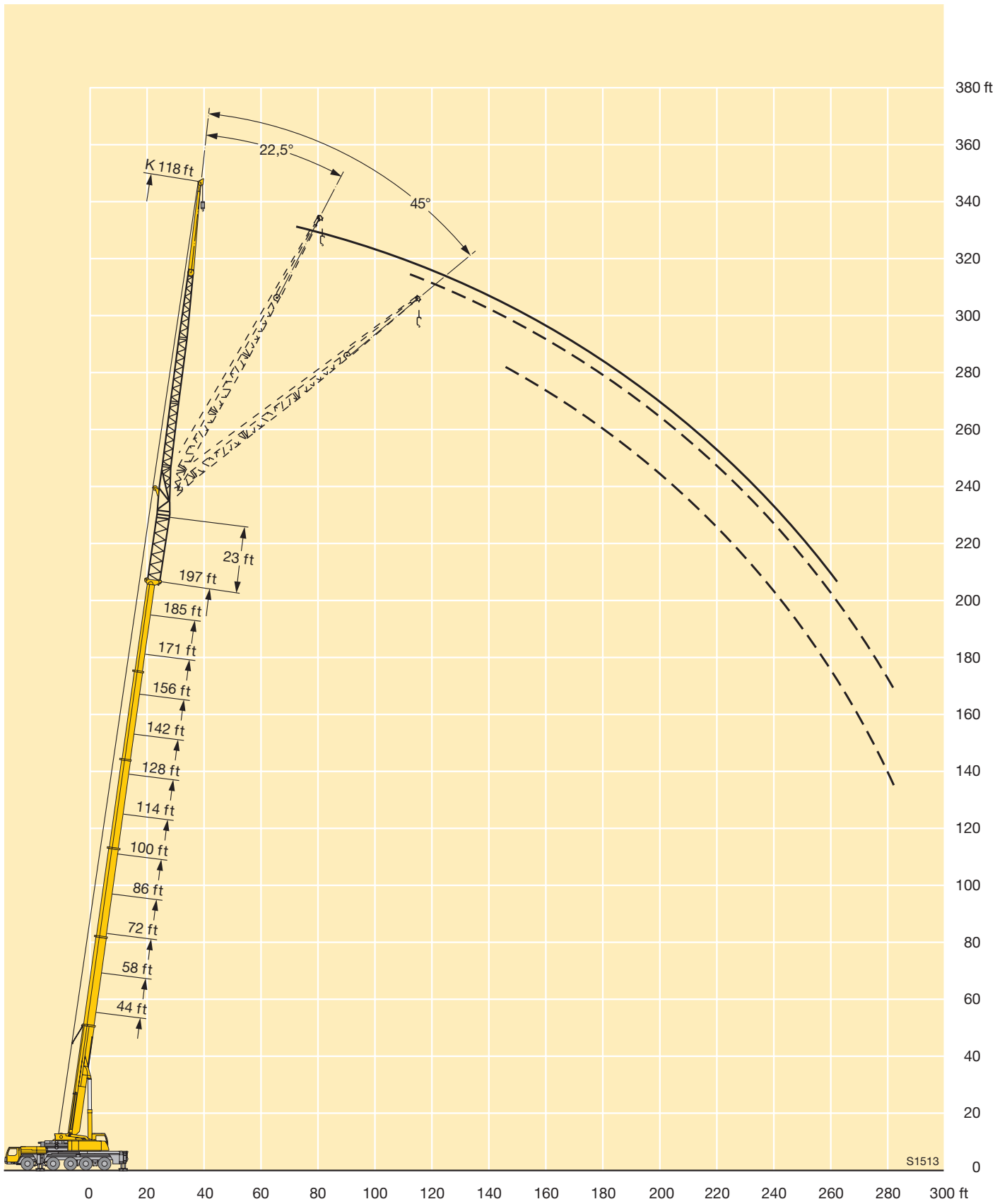

Lifting heights Hauteurs de levage

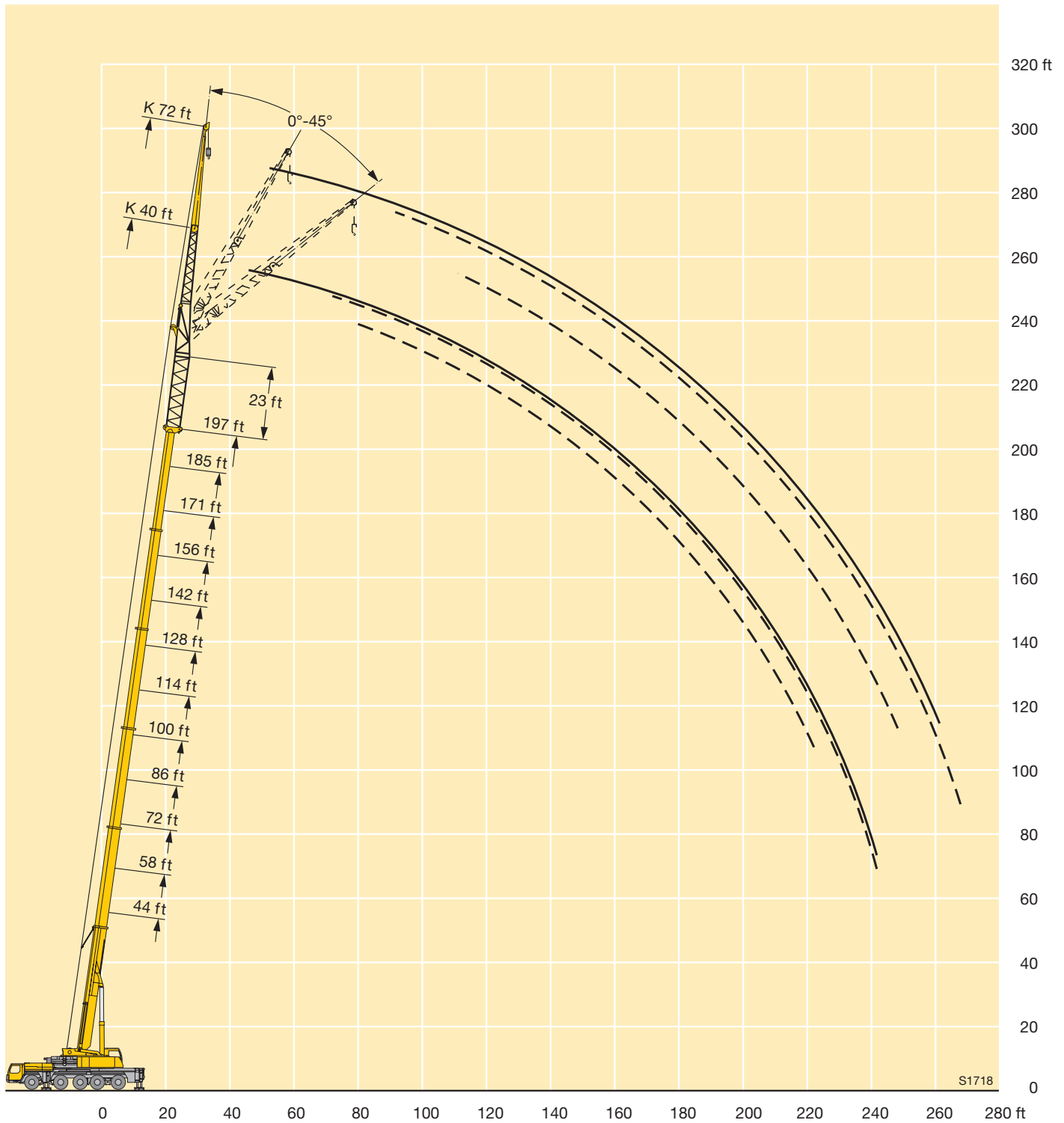

Lifting heights Hauteurs de levage

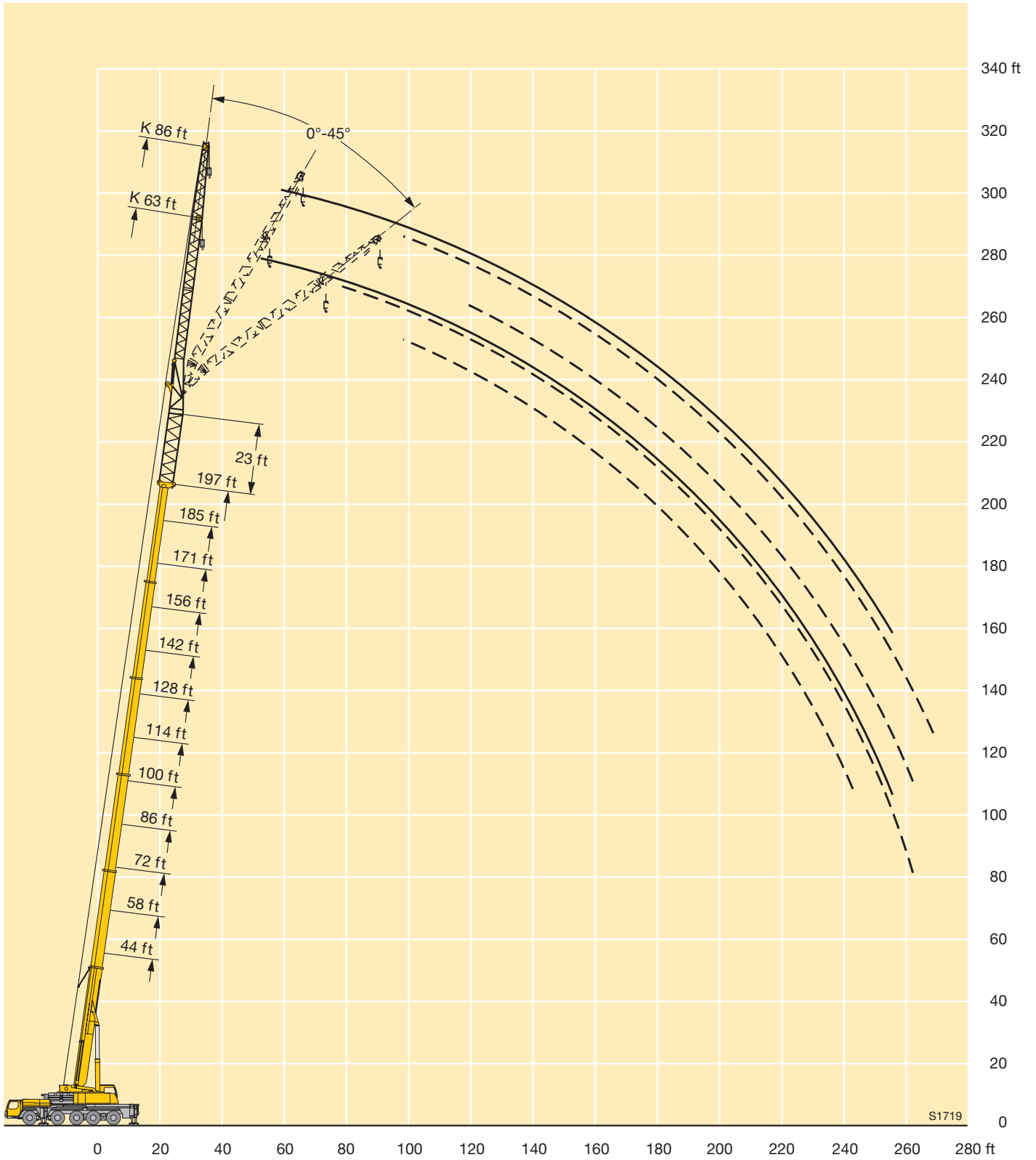

Lifting heights Hauteurs de levage

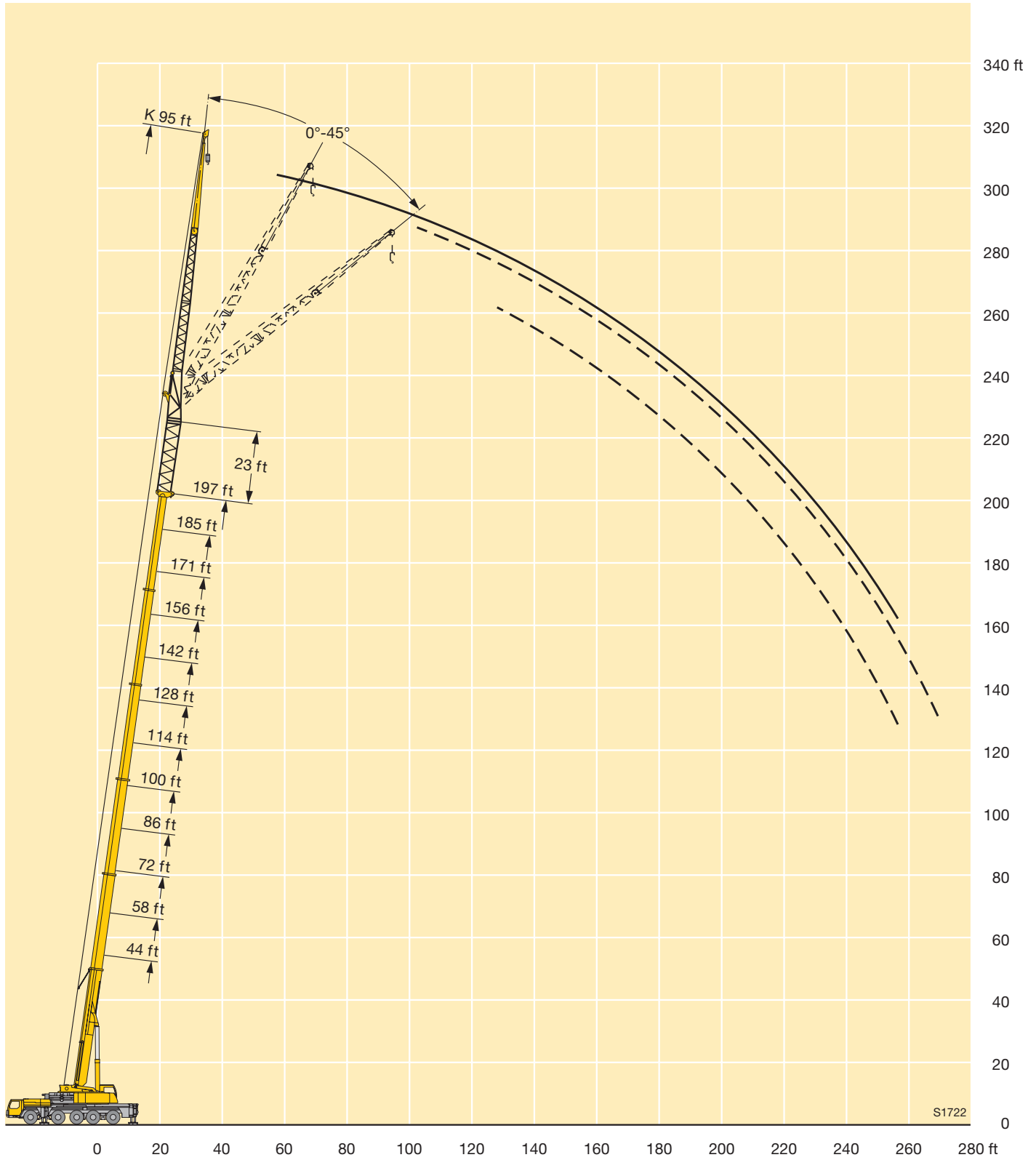

Lifting heights Hauteurs de levage

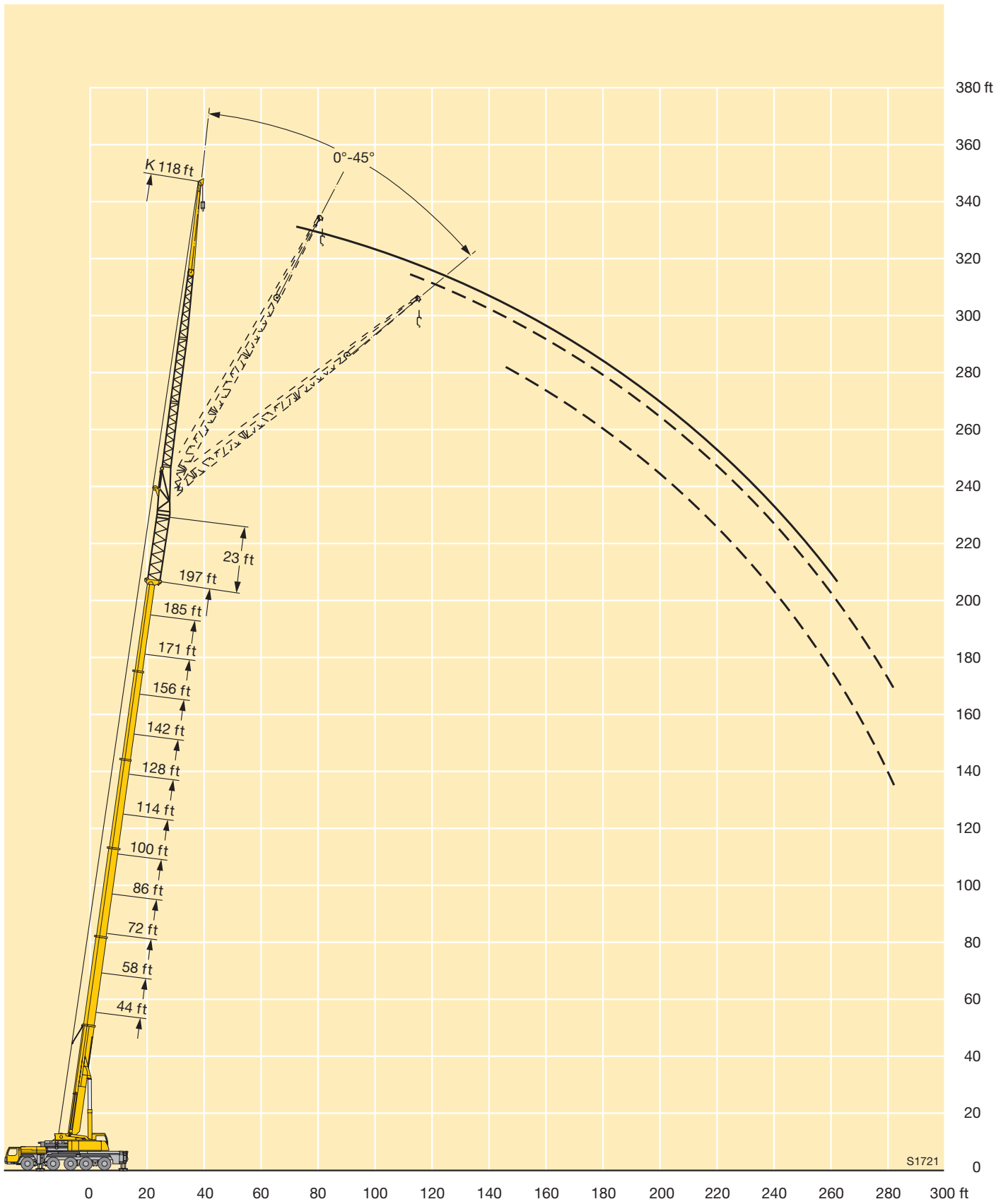

Dimensions Encombrement

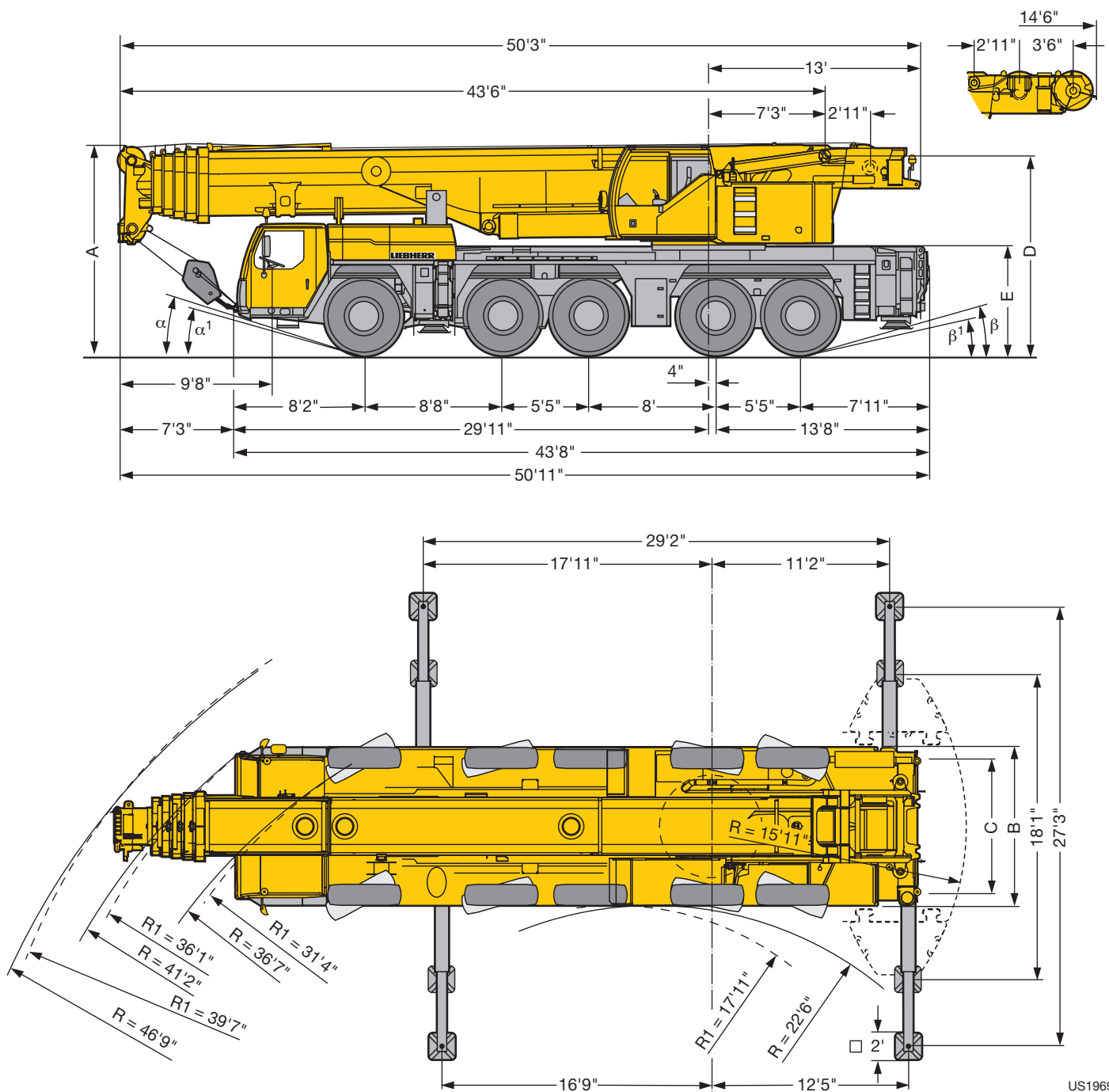

US1969

R₁ = All-wheel steering · Direction toutes roues

⊙	Dimensions / Encombrement									
	A	A 6" *	B	C	D	E	α	α_1	β	β_1
16.00 R 25	13'1"	12'8"	9'10"	8'4"	12'4"	6'9"	20°	16°	17°	14°
20.5 R 25	13'1"	12'8"	10'2"	8'5"	12'4"	6'9"	20°	16°	17°	14°

* lowered / abaissé